

# Sieve Analysis

Taking a close look at quality

An expert guide to particle size analysis



Copyright © 2015 by RETSCH GmbH Haan.  
All rights reserved, including the right to copy, distribute and translate this text. No part of this document may be reproduced in any way without written consent of RETSCH GmbH nor may be modified, copied or distributed with the help of electronic systems.

	Page
<b>Introduction</b> .....	<b>4</b>
<b>1. Sieve Analysis in Quality Control</b> .....	<b>5</b>
<b>2. Sieving Methods</b> .....	<b>8</b>
2.1. Vibratory Sieving .....	9
2.2. Horizontal Sieving .....	10
2.3. Tap Sieving .....	10
2.4. Air Jet Sieving .....	10
2.5. Option: Wet Sieving .....	11
<b>3. Sieve Analysis Procedures</b> .....	<b>12</b>
3.1. Sampling / Sample Division .....	12
3.2. Selection of the Sieves .....	15
3.3. Sieve Analysis Step by Step .....	15
3.3.1. Sieving with a Set of Sieves / Sieve Stack .....	16
3.3.2. Sieve Cut .....	16
3.3.3. Wet Sieving .....	17
3.4. Optimizing Sieving Time and Amplitude / Speed (rpm) .....	18
3.5. Sieving Aids to Support the Sieving Process .....	20
3.6. Cleaning of Test Sieves .....	21
<b>4. Evaluation and Interpretation of the Sieve Analysis</b> .....	<b>24</b>
4.1. Quantity Types $Q_{(x)}$ .....	26
4.2. Equivalent Diameter .....	28
4.3. Distribution Functions .....	29
<b>5. RETSCH Instruments</b> .....	<b>31</b>
5.1. Test Sieves .....	31
5.2. Analytical Sieve Shakers .....	34
5.3. Evaluation Software .....	39
5.4. Sample Dividers .....	40
5.5. Ultrasonic Baths .....	40
5.6. Fluid Bed Dryer .....	41
<b>6. Digital Image Analysis</b> .....	<b>42</b>
<b>7. Summary</b> .....	<b>45</b>
<b>8. Annex</b> .....	<b>45</b>
8.1. Sieve Standards with Comparison Table for Test Sieves .....	46
8.2. Sieve Certificates .....	48
8.3. Sieve Analysis Parameters .....	54t

## Introduction

For the characterization of bulk goods of different forms and sizes, the knowledge of their particle size distributions is essential. The particle size distribution, i.e. the number of particles of different sizes, is responsible for important physical and chemical properties such as solubility, flowability and surface reaction. In many industries such as food, pharmaceuticals and chemistry traditional sieve analysis is the standard for production and quality control of powders and granules. Advantages of the sieve analysis



include easy handling, low investment costs, precise and reproducible results in a comparably short time and the possibility to separate the particle size fractions. Therefore, this method is an accepted alternative to analysis methods using laser light or image processing.

To guarantee a high degree of reproducibility and reliability, sieve shakers and accessories have to fulfill the requirements of national and international standards. This means that test sieves, sieve shakers and all other measurement instruments (e.g. scales) which are used for the characterization of particle distributions have to be calibrated and subjected to test agent monitoring as part of the quality management system. Apart from that, it is absolutely necessary to carry out the sample preparation with great care. Only then is it possible to achieve sieving results which allow a reliable characterization of a product.

# 1. Sieve Analysis in Quality Control

We all know the term “quality”. It is widely used to describe a product of particularly high value. However, the exact definition of quality is as follows:

**Quality is the compliance of *defined properties* with the *detected properties* of a product as determined by performing tests.**

A product can be described as high-quality if a test measurement ascertains that the desired properties lie within a given tolerance. If the measured values deviate too much, the quality is lower.

Many materials, whether natural or artificial, occur in dispersed form (material which does not form a consistent unity but is divided into elements which can be separated from each other, e.g. a pile of sand). The particle sizes and their distribution within a material quantity - i.e. the fractions of particles of different sizes - have a crucial influence on physical and chemical properties.



**A few examples of properties which can be influenced by the particle size distribution:**

- the strength of concrete
- the taste of chocolate
- the dissolution properties of tablets
- the pourability and solubility of washing powders
- the surface activity of filter materials

These examples clearly show how important it is to know the particle size distribution, particularly within the context of quality assurance of bulk goods for production processes. If the particle size distribution changes during the production process, the quality of the product will change as well.

**Some examples taken from everyday life show how closely the particle size distribution is linked with product properties:**

- If the particles of **ground filter coffee** are too coarse, the contained flavors cannot dissolve completely in hot water. This is due to the fact that only the



flavors contained in the particle surface are washed out. Thus, the taste of the coffee cannot fully develop. Moreover, the water runs too quickly through the spaces between the particles and the filter. If the coffee is ground too fine, too many flavors, acids and bitter aromas are dissolved which impair the taste. Another disadvantage is the blocking of the fine-pored filter paper by ultra-fine particles which can even cause overflowing of the filter.

- **Abrasive papers and grinding pastes** need abrasive agents with a very narrow particle size distribution. Consequently, the particle sizes should not vary too much. Substantial deviations from the required size range may result in uneven surfaces: if the particles are too coarse, the paper/paste can leave deep grooves in the treated surface; if the particles are too fine, the grinding effect is reduced.
- **Activated carbon filters** in respiratory masks need a large reaction surface to efficiently absorb hazardous organic solvents from the air. The surface area is particularly influenced by the particle size. If the particles in the filter are too coarse, an efficient neutralization of the harmful vapors is not possible. If the particles are too fine, the person wearing the mask will have difficulties to breathe because the fine pores prevent sufficient amounts of air from passing.

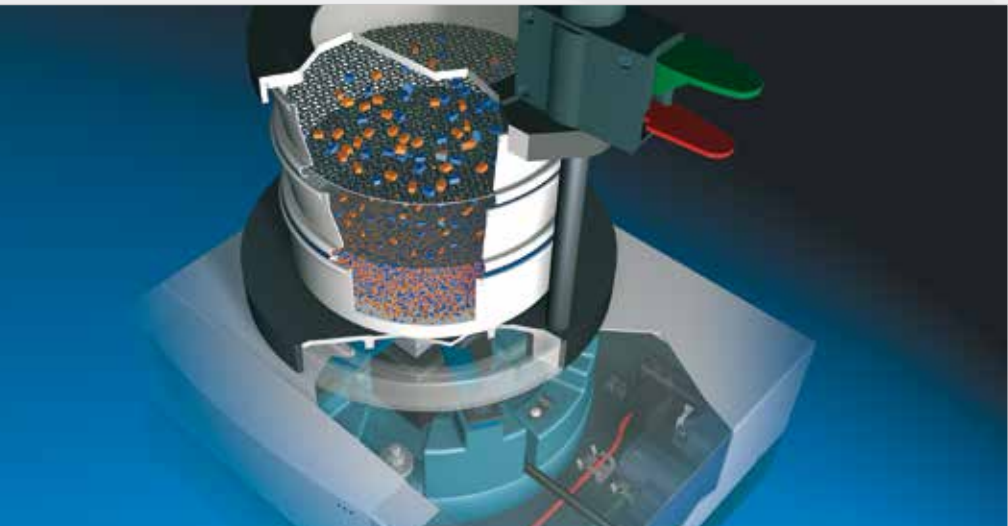

## 2. Sieving Methods

During sieving the sample is subjected to vertical movement (vibratory sieving) or horizontal motion (horizontal sieving). With tap sieve shakers both movements are superimposed. During this process the particles are compared with the apertures of every single sieve. The probability of a particle passing through the sieve mesh is determined by the ratio of the particle size to the sieve openings, the orientation of the particle and the number of encounters between the particle and the mesh openings.

Single sieving is carried out with one test sieve of a defined mesh size and is used to determine the percentages of undersize and oversize. It is used to get a general idea of the sample characteristics (**sieve cut**). A particle size distribution in the actual sense is not obtained with this method.

If more fractions are required, a **set of sieves** is used. The sieves are arranged in a stack with the mesh size increasing from bottom to top. The sample is then placed on the top sieve.

The appropriate sieving method depends on the **degree of fineness** of the sample material (fig. 1). Dry sieving is the preferred method for the size range between 40  $\mu\text{m}$  and 125 mm. However, the measurement range is limited by properties of the sample such as a tendency to agglomerate, density or electrostatic charging.

Wet sieving extends the measurement range to 20  $\mu\text{m}$ . If wet sieving is not permitted, air jet sieving is an alternative which provides acceptable results down to 10  $\mu\text{m}$ .

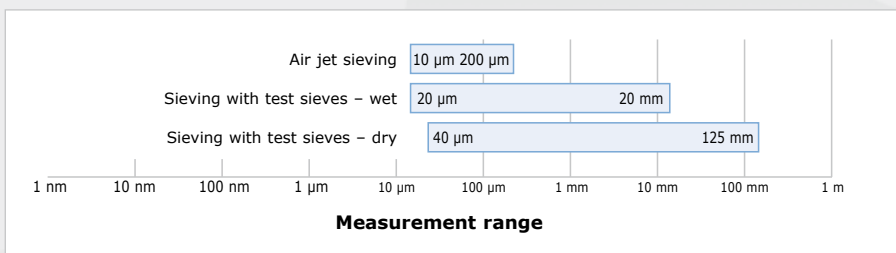

Fig. 1:  
Measurement ranges of  
different sieving methods



## 2.1. Vibratory Sieving

The sample is thrown upwards by the vibrations of the sieve bottom and falls back down due to gravitation forces. The amplitude indicates the vertical oscillation height of the sieve bottom.

With **vibratory sieving**, the sample is subjected to a 3-dimensional movement, i.e. a circular motion superimposes the vertical throwing motion (fig. 2, left).

Due to this combined motion, the sample material is spread uniformly across the whole sieve area. The particles are accelerated in vertical direction, rotate freely and then fall back statistically oriented. In RETSCH sieve shakers, an electromagnetic drive sets a spring/mass system in motion and transfers the oscillations to the sieve stack. The amplitude can be adjusted continuously to a few millimeters.

RETSCH "control" sieve shakers allow the digital setting of amplitude and sieving time. During the sieving process, a built-in measuring system and control unit performs a continuous comparison between the set and actual amplitude values which ensures a high degree of reproducibility.



Fig. 2:  
Principles of 3-dimensional throwing motion (left),  
horizontal sieving (middle) and tap sieving (right)

## 2.2. Horizontal Sieving

In a horizontal sieve shaker the sieves move in horizontal circles in a plane (fig. 2, middle). Horizontal sieve shakers are preferably used for needle-shaped, flat, long or fibrous samples. Due to the horizontal sieving motion, hardly any particles change their orientation on the sieve.

## 2.3. Tap Sieving

In a tap sieve shaker a horizontal, circular movement is superimposed by a vertical motion generated by a tapping impulse (fig. 2, right). Tap sieve shakers are specified in various standards for particle size analysis.

The number of comparisons between particles and sieve apertures is substantially lower in tap sieve shakers than in vibratory sieve shakers ( $2.5 \text{ s}^{-1}$  as compared to  $\sim 50 \text{ s}^{-1}$ ) which results in longer sieving times. On the other hand, the tapping motion gives the particles a greater impulse, therefore, with some materials, such as abrasives, the fraction of fine particles is usually higher. With light materials such as talcum or flour however, the fraction of fine particles is lower.

## 2.4. Air Jet Sieving

The air jet sieve is a sieving machine for single sieving, i.e. for each sieving process only one sieve is used. The sieve itself is not moved during the process.

The material on the sieve is moved by a rotating jet of air: A vacuum cleaner which is connected to the sieving machine generates a vacuum inside the sieving chamber and sucks in fresh air through a rotating slit nozzle. When passing the narrow slit of the nozzle the air stream is accelerated and blown against the sieve mesh, dispersing the particles. Above the mesh, the air jet is distributed over the complete sieve surface and is sucked in with low speed through the sieve mesh. Thus the finer particles are transported through the mesh openings into the vacuum cleaner or, optionally, into a cyclone.

The sieve analysis starts with the smallest mesh size; the undersize is determined by weighing the material before and after sieving. If a size distribution curve is required, this procedure is continued with increasing mesh sizes. The oversize on the finer sieve is put on the sieve next in size and is sieved again.

Air jet sieving is used, for example, for the continuous and quick control of classifying processes.

## 2.5. Option: Wet Sieving

Most sieve analyses are carried out with dry materials. However, there are many applications in which wet sieving cannot be avoided, e.g. if the material to be tested is a suspension or if a very fine sample ( $< 45 \mu\text{m}$ ) that tends to agglomerate has to be sieved. Dry sieving would lead to blockage of the sieve.

As in dry sieving, a sieve stack is assembled on a sieve shaker. The sample is placed on the top sieve in the form of a suspension. The sieving process is supported by water from a spray nozzle located above the uppermost sieve. Rinsing is carried out until the sieving liquid leaving the sieve stack outlet is no longer clouded with solid particles. If this finest fraction is required for analysis, it has to be recovered with the help of a very fine filter and can be weighed after drying (see also chapter 3.3.3.).

**Important note:** The water should not alter the sample in any way, i.e. the particles should not swell, dissolve or react with the liquid.

During wet sieving it may occur that air cushions are formed between the sieves. This effect is caused by the fact that the sieves form a dust- and liquid-tight stack which helps to avoid material loss and cross-contamination. The mesh sizes below 100 microns are particularly affected by this. By placing RETSCH's venting rings between the sieves, this effect can be avoided. With these rings the air cushions can expand without loss of liquid or sample material.

## 3. Sieve Analysis Procedures

Besides the actual sieve analysis, the sieving process also includes preparatory steps such as sampling, sample division (if necessary), and the selection of test sieves. After the sieving process, the data is evaluated, the sample material is recovered and the sieves are cleaned and dried. To obtain reproducible sieving results, it is essential that all steps of the sieving process are carried out with precise and reliable instruments (sieve shaker, scales). An evaluation software greatly reduces the time needed for recording and evaluating the data and also helps to minimize data transfer errors.

### 3.1. Sampling / Sample Division

The importance of sampling is demonstrated in figure 3: Even if the analysis is carried out correctly, random sampling (e.g. with a scoop) leads to varying results which are not reproducible although the samples come from the same initial material. As shown in figure 3, three different samples taken from the same initial material show variations of up to 20 % for the fraction below 2 mm.

*Fig. 3:  
Random sampling  
with scoop; three  
correct sieve  
analyses lead to  
three different  
results*

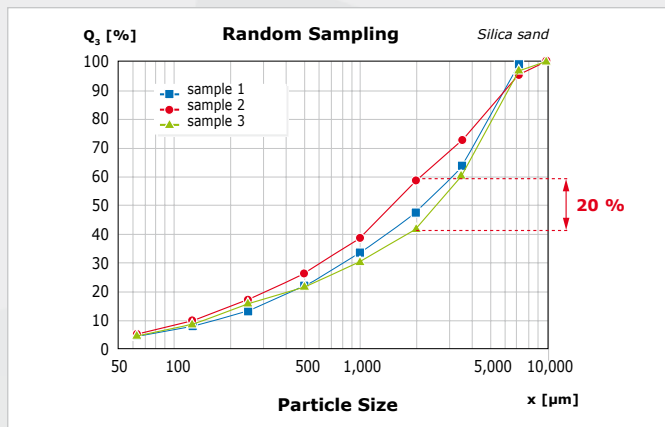

Therefore, it is essential that sampling is carried out with utmost care. A basic requirement for reproducible sieve analysis is the extraction of a **representative sub-sample** from the bulk. Representative means that the properties of the sub-sample, in this case the particle size distribution, have to be identical with those of the bulk.

Sampling of large volumes of bulk materials, such as ship or train loads, can be rather difficult. To obtain a representative sub-sample, it is necessary to take samples from various locations and mix them together. Samples can also be taken from the material flow of a production unit.

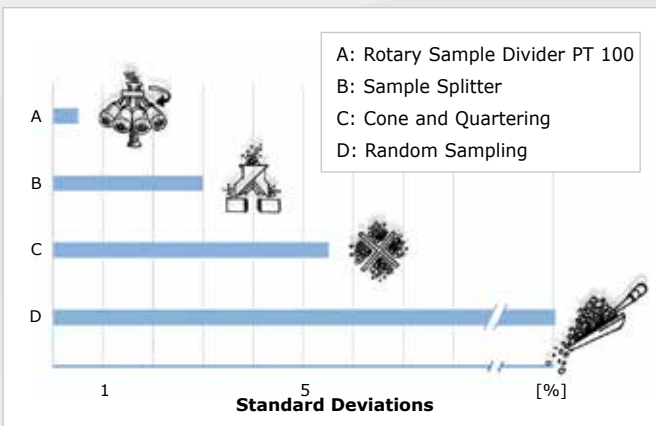

*Fig. 4: Qualitative sampling errors (standard deviations) of the different sampling methods*

The bulk sample obtained is often bigger than the amount of material a sieve shaker can process. The **maximum batch** depends on various factors such as number and aperture size of the sieves, maximum grain size and width of distribution of the sample. The standard **DIN 66165** provides more details, e.g. the maximum amount of oversize grain which should remain on a square decimeter of sieve bottom. The oversize grain on a sieve with a mesh size of 1 mm, for example, should not be more than 20 cm<sup>3</sup> per square decimeter. For a 200 mm sieve that equals to 63 cm<sup>3</sup> oversize, for a 400 mm sieve it is 252 cm<sup>3</sup>. The maximum batch should not exceed twice the amount of the oversize value, i.e. a 200 mm sieve with mesh size 1 mm should not be filled with more than 126 cm<sup>3</sup> sample material. By multiplying these values with the bulk density, the corresponding masses can be obtained.

**Examples for the maximum batch and permitted sieve oversize for 200 mm sieves:**

mesh size	max. batch	max. permitted sieve oversize
25 µm	14 cm <sup>3</sup>	7 cm <sup>3</sup>
45 µm	20 cm <sup>3</sup>	10 cm <sup>3</sup>
63 µm	26 cm <sup>3</sup>	13 cm <sup>3</sup>
125 µm	38 cm <sup>3</sup>	19 cm <sup>3</sup>
250 µm	58 cm <sup>3</sup>	29 cm <sup>3</sup>
500 µm	88 cm <sup>3</sup>	44 cm <sup>3</sup>
1 mm	126 cm <sup>3</sup>	63 cm <sup>3</sup>
2 mm	220 cm <sup>3</sup>	110 cm <sup>3</sup>
4 mm	346 cm <sup>3</sup>	173 cm <sup>3</sup>
8 mm	566 cm <sup>3</sup>	283 cm <sup>3</sup>

Professional **sample dividers** with a marginal standard deviation should be used for the extraction of representative sub-samples. Figure 4 shows the qualitative sampling errors of the different methods. It can clearly be seen that rotary tube sample dividers produce the smallest qualitative variation (A). They achieve the highest degree of reproducibility and are clearly superior to all other methods.

**Important note:** For a sieve analysis at least one complete sub-sample, obtained by sample division, is needed.

### 3.2. Selection of the Sieves

The selection of the sieves depends on the sample quantity (as mentioned above) but also on the particle size distribution. The mesh sizes of the sieve stack should cover the complete size range of the sample in regular intervals. The wider the size range of the sample, the more sieves should be used. The standards (see chapter 7.1. Principal sizes, Supplementary sizes) can help to determine the suitable mesh sizes.

### 3.3. Sieve Analysis Step by Step

First, the empty sieves have to be weighed. The sample must be weighed as well to ensure that material loss can be recognized or excluded.

To evaluate the sieving process, the oversize (fraction) on each sieve bottom must be determined with regards to volume and mass. The most common method is to **weigh the fractions**. Each sieve is weighed with the oversize from which the weight of the empty sieve is then subtracted. The evaluation of the sieving process is described in chapter 4.

After that, the sample material can be recovered from the sieves. The **retrieval of the individual fractions** is a significant advantage of sieve analysis in contrast to most optical measurement systems. The fractions are not only analytical values but are physically available.

### 3.3.1. Sieving with a Set of Sieves/Sieve Stack

**In general, sieving with a sieve stack is used to determine the particle size distribution:**

- Put together a sieve stack with collecting pan (see chapter 3.2.)
- Determine the empty weight of sieves/collecting pan\*
- Put the sieves with increasing mesh size on the collecting pan
- Weigh the sample and put it on the uppermost sieve (biggest mesh size) (observe max. feed capacity)\*
- Put the complete sieve stack filled with the sample material on the sieve shaker and fasten it
- Set a suitable amplitude and sieving time on the sieve shaker (see chapter 3.4.)
- Start the sieve shaker\*
- When the sieving time has expired each sieve and the collecting pan have to be weighed with the fraction on it\*
- The mass of each fraction is determined\* (Weight after sieving minus empty weight)
- Evaluation\*

\* The evaluation software EasySieve® automatically records the weights and allows for a quick and simple evaluation of the sieve analysis. All RETSCH sieve shakers of the "control" series can be controlled with EasySieve®.

### 3.3.2. Sieve Cut

In some cases it may be sufficient to determine the percentage of oversize and undersize of a sample. This single sieving usually only serves as an orientation, e.g. to evaluate the results of a size reduction process.



To obtain a sieve cut, a sieve with a defined mesh size and a collecting pan are subjected to the sieving motion; apart from that the whole process is comparable to sieving with a set of sieves.

The sieve cut is also used for air jet sieving.

### 3.3.3. Wet Sieving

Usually, sieving processes are carried out with dry material. However, when dry sieving cannot produce an adequate degree of separation between the individual fractions and the sieving quality cannot be improved by sieving aids, wet sieving is called for.

In addition to the sieve set, wet sieving requires a clamping cover with spray nozzle as well as a collector with outlet. The sieving process is supported by water from the spray nozzle which is located above the uppermost sieve. The water leaves the sieve stack carrying the last fraction through the outlet in the collector. Rinsing is carried out until the liquid leaving the pan outlet is no longer clouded with solid particles.

- The material to be sieved is mixed with water until it becomes a suspension. To reduce the surface tension and facilitate passage of the material, a few drops of surfactant may be added.
- Put together the sieve stack with a collecting pan with outlet (see chapter 3.2.).
- Moisten each sieve with water and place them on top of the collector with outlet.
- Place venting rings between the sieves to permit the expansion of air cushions (for sieves < 100 µm).
- Place the complete stack on the sieve shaker.
- If the smallest fraction that leaves the sieve stack should be weighed, too, it has to be collected by filtration.
- Place the suspension on the uppermost sieve (cover must be open).

- Fix the clamping device.
- Recommended parameters:  
amplitude of 1 – 1.2 mm in interval mode, time: 5 min  
(in most cases, 2-3 min is sufficient for a sieving process).
- Start the sieve shaker.
- Turn on the water supply.
- Observe the liquid leaving the outlet. Sieving is finished when the liquid is clear.
- Turn off water supply and sieve shaker.
- Put the fractions from each sieve into a paper filter and into a drying oven (at 105 °C, until weight remains constant).
- Weigh the fractions and evaluate the results with EasySieve®.
- If the initial weight of the dry material is known, the smallest fraction can be calculated, even if it wasn't collected:  
"initial weight" – "total of fractions" = "smallest fraction"

### **3.4. Optimizing Sieving Time and Amplitude/Speed (rpm)**

The ideal parameters for sieving time and amplitude/speed depend on the material to be sieved. They have a crucial influence on the sieving result.

Usually, national and international standards and internal regulations provide plenty of product-specific information about sieve analyses and the corresponding parameters. If such basic information cannot be obtained, the best sieving time and amplitude have to be determined experimentally.

Figure 5 shows how different **amplitudes** can influence the sieving result. Three trials were carried out: silica sand was sieved for 5 minutes with amplitudes of 0.5 mm, 1.2 mm and 2 mm. The highest sieve undersize is achieved with an amplitude of 1.2 mm. There is a simple explanation for this result: if the amplitude is too low, the particles don't lift off high enough from the sieve bottom which means they cannot orientate freely or move freely over the sieve area. If the amplitude is too high, the particles are thrown too high upwards and thus have less opportunities to compare with the apertures of the sieve.

The probability of a particle passing the mesh is at its optimum when the throw time corresponds to a period in the sieve bottom vibration. In such a case the sieving material will be moved with a different orientation to a different sieve aperture every time the sieve bottom lifts. This state is called **statistical resonance** (see fig. 6). The best results are usually achieved with amplitudes between 1.2 and 1.3 mm.

The optimal **sieving time** according to DIN 66165 is achieved if, after one minute of sieving, less than 0.1% of the feed quantity passes the sieve. If the undersize is larger, the sieving time should be prolonged.

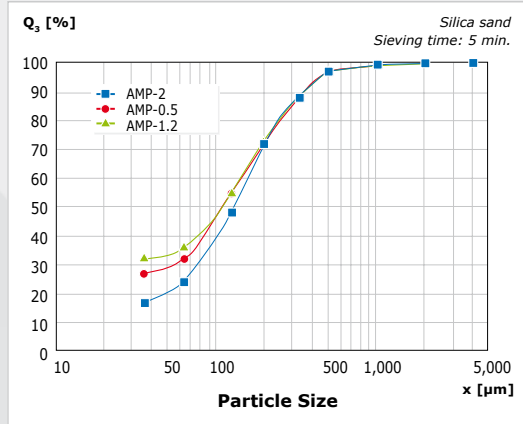

Fig. 5: The influence of different amplitudes on the sieving result

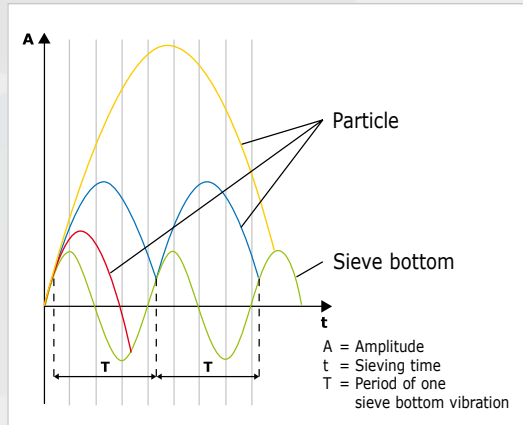

Fig. 6: Movement of particles in relation to sieve bottom; blue graph: particle is in statistical resonance with sieve bottom; red graph: particle falls down too quickly; yellow graph: particle was thrown up too high

### 3.5. Sieving Aids to Support the Sieving Process

Reciprocal effects between particles have a decisive influence on the „sieveability“ of a material. Examples for this are the intermolecular Van der Waals forces (dipole-dipole interaction), fluid bridges in samples with residual moisture or frictional effects caused by electrostatic charging (fig. 7).

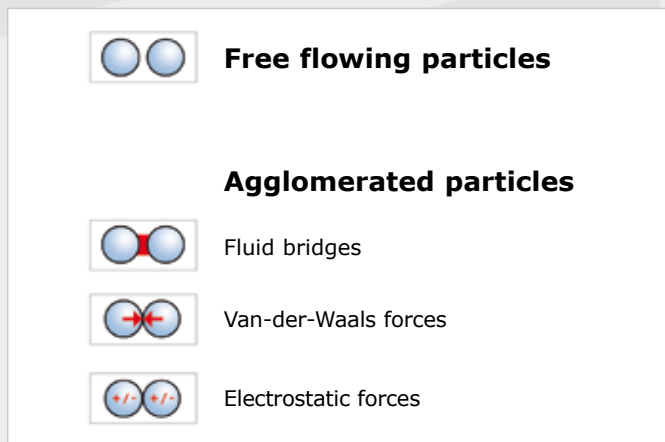

Fig. 7:  
Adhesive forces among particles which may affect the sieving result

These adhesive forces cause agglomeration of the particles. Particle size and shape have an additional influence, e.g. if the particle surface is very rough or fissured, the particles agglomerate by interlocking.

Agglomerates falsify the particle size distribution because particle collectives are measured instead of individual particles with the result that the percentage of coarse particles is too high.

To prevent the formation of agglomerates or dissolve them, sieving aids can be used.

**There are three groups of sieving aids::**

- (a) Mechanical sieving aids** (e.g. rubber cubes, brushes, agate, rubber or steatite balls, chain rings): They destroy agglomerates and dislodge wedged particles from the sieve mesh.
- (b) Solid additives** (e.g. talcum, Aerosil®) are mainly used for fatty, moist, sticky and oily products: They are mixed with the sample, attach themselves to the particle surface and bind the unwanted components. Their particle size is so small that their influence on the actual particle size analysis is marginal.
- (c) Liquid additives** (e.g. anti-static spray, benzene, alcohol, surfactant): They either reduce electrostatic charges, wash out fatty or oily components or reduce the surface tension in wet sieving processes.

### **3.6. Cleaning of Test Sieves**

Test sieves are measuring instruments. To ensure a long service life, sieves should be treated with care before, during and after sieving. It is recommended to clean new sieves from possible preservative residues with ethanol or isopropyl. Sieves should be stored in a dry and dust-free place.

By no means should the sample be forced through the sieve mesh during the sieving process. Even a light brushing of the material – particularly through very fine fabric – or the use of mechanical sieving aids (such as metal balls, cubes or chain rings) can lead to changes of the mesh and damage the sieve wire gauze.

When the sieving is done, the fractions are taken from each sieve. Near-mesh particles, which are trapped in the sieve mesh, can be removed by turning the sieve upside down and tapping it lightly on a table. If not all particles can be recovered like that, it is also possible to sweep a fine hair pencil over the outer side of the fabric. Coarser fabrics with mesh sizes > 500 microns can be effectively cleaned dry or wet with a hand brush with plastic bristles. Possible damage of the wire gauze by these tools is highly unlikely.

Sieves with a mesh size below 500 microns should generally only be cleaned in an ultrasonic bath. The high intensity of the ultrasound helps to remove near-mesh particles from the fine fabrics. The cleaning process is gentle as no mechanical forces are involved.

As cleaning agent, water together with a standard surfactant is recommended. Cleaning in an ultrasonic bath usually takes about 2 – 3 minutes. After that the sieves are thoroughly rinsed with water and dried. It is not recommended to use strong lye or acid. Only in exceptional cases is it acceptable to use 5% acetic acid or sodium carbonate solution to remove finest particles from the sieve mesh. In such cases the sieves should be rinsed extra carefully with water to remove all possible residues which could cause corrosion.

Drying cabinets of various sizes can be used for drying test sieves. It is recommended to place the sieves vertically into the cabinet at a temperature not higher than 80 °C. With higher temperatures especially the fine metal wire mesh could become warped; the tension of the fabric inside the sieve frame is reduced which makes the sieve less efficient during the sieving process.

Test sieves with a diameter of 200 mm can be best dried in RETSCH's rapid dryer TG 200. The wet sieves are stacked together – this time, however, starting with the biggest mesh size at the bottom, so that the smallest sieve is on top. A pre-heated variable air flow blows through the stack and accelerates the drying process. After only 3 – 5 minutes the sieves are dry and can be used again.

Before cleaning or drying the sieves, the rubber or plastic seal rings have to be removed.

Before using the sieves again after cleaning, a visual inspection for cleanness and possible damages is recommended. By holding the sieve against the daylight, sample residues, fissures or holes in the fabric become visible. Holding the sieve bottom slightly inclined makes it easier to detect bumps, bulges or ripples in the wire gauze. If such deviations are detected, the sieve can no longer be used for quality control and must be replaced (please refer to the recommendations of DIN ISO 3310).

The correct handling, cleaning, drying and storing of the test sieves ensures their long service life and accuracy.

# 4. Evaluation and Interpretation of the Sieve Analysis

<b>Sieve Analysis Results</b>				
Sample volume: 150 grams = 100 %				
Parameters: time = 4 minutes, amplitude = 1.3 mm				
Sieve [µm]	Net Weight [g]	Weight after sieving	Difference [g]	Percentage [%]
Bottom	501	505.5	4.5	3
45	253	259	6	4
63	268	283	15	10
140	298	328	30	20
250	325	373	48	32
500	362	384.5	22.5	15
1,000	386	401	15	10
2,000	406	412	6	4
4,000	425	428	3	2
= 150 g = 100 %				

Fig. 8: Calculation of the proportionate oversize in each fraction

As described in chapter 3.3. the empty sieves are weighed before, and the sieves with the oversize grain after the sieving process (fig. 8, net weight, weight after sieving). The difference between these values corresponds to the weight of the individual fractions. When this is related to the total feed quantity, the result is the percentage of each fraction of the total sample amount.

The difference between the original sample weight and the sum of the individual fractions is the sieving loss. According to DIN 66165 the sieving process must be repeated if the loss is greater than 1%.

The percentage mass fractions can be shown as a histogram. The example in figure 9 shows the greatest fraction (32%) in the size range between 250 and 500 µm.

By adding up the individual fractions and interpolation between the points of measurement the cumulative distribution curve  $Q_3$  (fig. 10) is obtained.

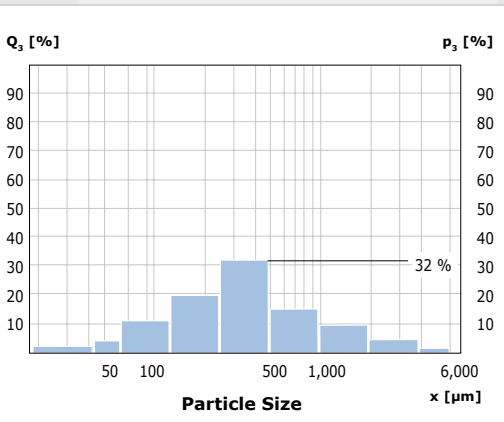

Fig. 9: Histogram of the individual fractions



The cumulative curve in figure 11 can be interpreted as follows: The corresponding value of the particle size 250  $\mu\text{m}$  on the y-axis is 36%. This means that 36% of the sample is smaller than 250  $\mu\text{m}$ . To determine the median  $Q_3(50)$  of the distribution, the corresponding grain size (330  $\mu\text{m}$ ) can be read off the x-axis, which means 50% of the sample are smaller than or equal 330  $\mu\text{m}$ . The same method can be applied to determine the results for different  $x(Q_3)$  and  $Q_3(x)$  values of the sample.

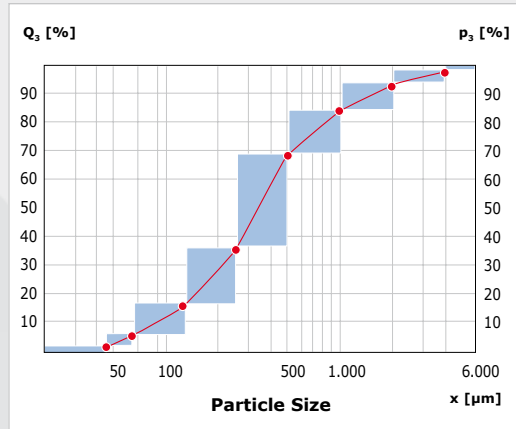

Fig. 10:  
 Histogram with cumulative distribution curve

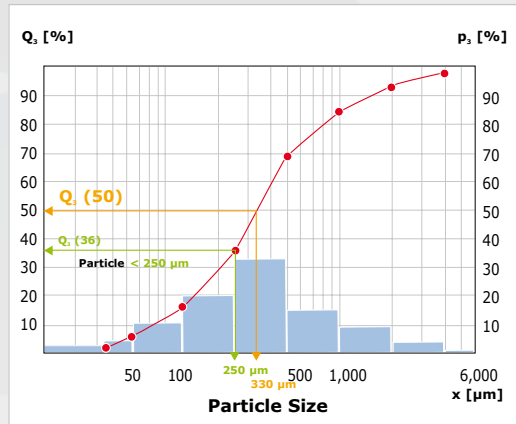
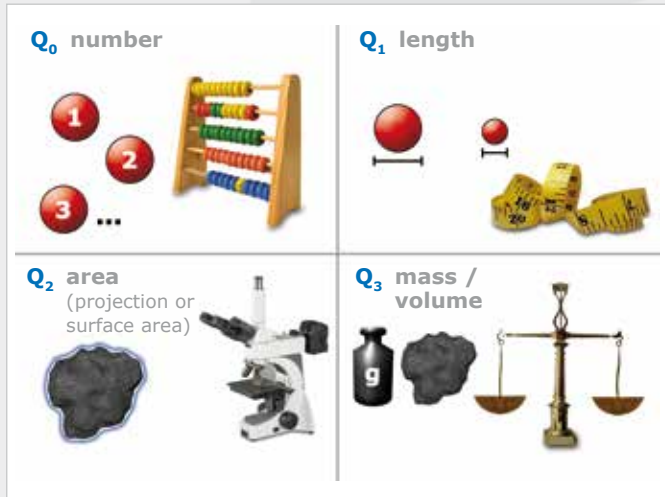

Fig. 11:  
 Cumulative distribution curve with exemplary percentage values

## 4.1. Quantity Types $Q_{(x)}$

In the previous paragraph the term  $Q_3$  was used in the context of cumulative distribution. The index 3 indicates that the cumulative curve is related to **mass** or **volume** (third dimension). It means that the single fractions have been weighed or their volume has been determined with the help of a volumetric flask. The **length** distribution  $Q_1$  and the **area** distribution  $Q_2$  can also be used to display a measurement result (fig. 12). For the **number** distribution  $Q_0$  the particles of a fraction are counted, e.g. with a microscope.

Fig. 12:  
Definitions of the  
quantifications  $Q_r$  of  
particle collectives



The volume- or number-related display of the cumulative distribution can lead to different curve progressions (fig. 13). The red curve is number-related and shows a high percentage (approx. 20%) of particles below 100  $\mu\text{m}$ . Due to its low weight/volume this fraction of fine particles is not visible in the  $Q_3$  distribution curve. It only shows particles which are larger than 400  $\mu\text{m}$ .

The differences become clear when regarding the following example (fig. 14): A cube with an edge length of 10 mm is subdivided in 1000 small cubes with an edge length of 1 mm each. With the volume-related distribution, 50% of the sample are represented by the big cube and 50% by the small cubes. With the number-related distribution the big cube only represents 1/1000 of the total sample.

To obtain comparable results it is of great importance to use the same quantification method  $Q_r$ .

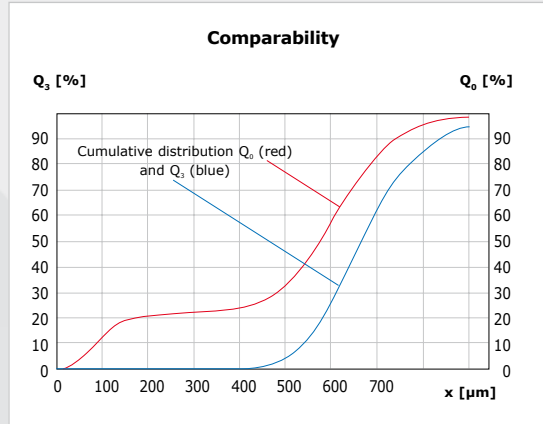

Fig. 13: Difference between number-related ( $Q_0$ ) and volume-related ( $Q_3$ ) display of the cumulative distribution  $Q_r$

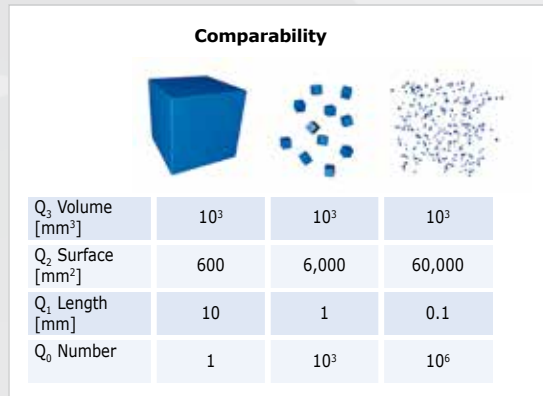

Fig. 14: Distribution of surface, length and number of cube collectives of the same total volume

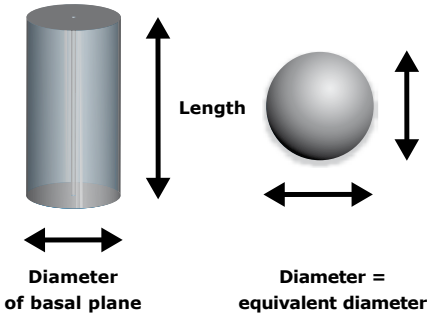

Fig. 15:  
Comparison between stick and sphere  
(diameter of basal plane or  
diameter of sphere = equivalent diameter)

## 4.2. Equivalent Diameter

What exactly does the result of a sieve analysis tell us about the particle size? Let's take a 1 mm sieve as an example. A sphere which passes this sieve has a diameter of less than 1 mm. For irregular shaped particles, e.g. coins or sticks, this is more complicated. In contrast to the spheres, these particles only pass the sieve when they have a certain orientation. During sieving, a particle hits the sieve mesh until it passes with its smallest projection screen through an aperture. The projection surface is the 2-dimensional "shadow" of the particles.

This means that a stick (fig. 15) passes the sieve mesh if the diameter of its basal plane is less than 1 mm, regardless of its length. Thus, the **equivalent diameter** of the particle is less than 1 mm. The equivalent diameter of a non-spherical particle is equal to a diameter of a spherical particle that shows identical properties. This means that irregular shaped particles are considered as spheres whose size can be narrowed down with the help of sieving. However, sieve analysis does not provide any information about the particle shape such as the longitudinal extension of a stick etc.

Flat or lentiform particles can pass the sieve mesh diagonally (fig. 16). This means that the equivalent diameter of the particle is smaller than the diameter of its surface but bigger than its thickness.

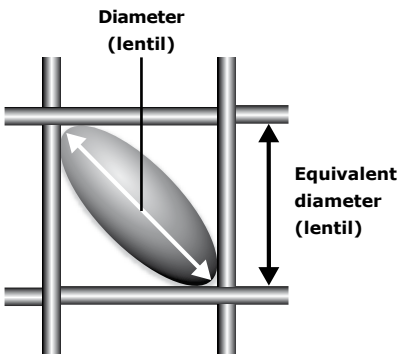

Fig. 16:  
A lentiform particle can pass the  
sieve mesh with diagonal orientation  
(diameter > equivalent diameter)

### 4.3. Distribution Functions

Particle collectives are characterized by and comparable with the help of a **frequency distribution curve**  $q_r(x)$  or a **cumulative distribution curve**  $Q_r(x)$  (fig. 18). The individual size fractions can also be displayed as a **histogram** (bar graph), expressed through  $p_r$  (fig. 19). The cumulative distribution curve  $Q_r(x)$  is scaled to the total amount of measured particles (%) with  $Q_r(x)$  being dimensionless.

If  $x_2 = x_1 + \Delta x$  is the difference of the mass fractions of two equivalent diameters, the result is

$$\Delta Q_r(x_1, x_2) = Q_r(x_2) - Q_r(x_1)$$

(equation 1)

The frequency distribution  $q_r(x_1, x_2)$  for  $x_1$  and  $x_2$  is:

$$q_r(x_1, x_2) = \frac{\Delta Q_r(x_1, x_2)}{\Delta x} = \frac{Q_r(x_2) - Q_r(x_1)}{x_2 - x_1}$$

(equation 2)

Provided  $Q_r(x)$  is a differentiable function, the frequency distribution curve  $q_r(x)$  is obtained by the derivative of  $Q_r$  with respect to  $x$ :

$$q_r(x) = \frac{dQ_r(x)}{dx}$$

(equation 3)

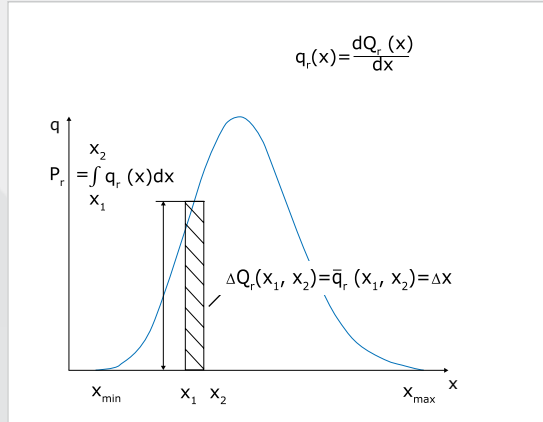

Fig. 17:  
Frequency distribution curve  $q_r(x)$

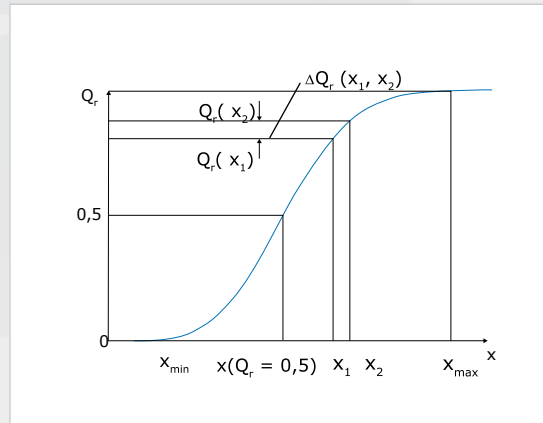

Fig. 18:  
Cumulative distribution curve  $Q_r(x)$

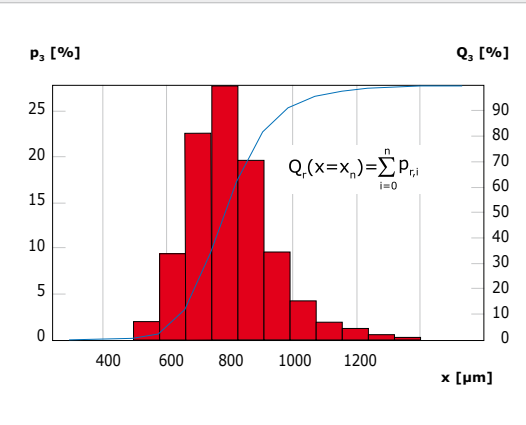

Fig. 19:  
The quantity proportions  $p_r$  (histogram)  
of the individual fractions

The higher the percentage of the sample in interval  $x_2 - x_1$ , the steeper the cumulative distribution curve in this section, i.e.  $\Delta Q_r(x_2, x_1)$  has a high value. If  $Q_r(x)$  is a differentiable function, the slope of the cumulative curve, and thus the relative frequency by number of a particle size, for each equivalent diameter  $x$  can be obtained by derivative. If  $q_r(x)$  is high, the cumulative curve is steep, if it is low, the curve is flat.

As  $x$  corresponds to the equivalent diameter,  $q_r(x)$  has the dimension of %/length. The form of the frequency distribution curve often corresponds to the Gaussian distribution with a peak, representing a so-called monomodal distribution. If there are two or more peaks, the distribution is called bimodal or multimodal.

For sieve analysis it is very important to display the frequency distribution in the form of a histogram (fig. 19). The intervals  $\Delta x$  are given by the differences of adjacent mesh openings. The difference of the mass fractions becomes

$$p_r(x_1, x_2) = \Delta Q_r(x_1, x_2) \approx \bar{q}_r(x_1, x_2) \cdot \Delta x \quad (\text{equation 4})$$

$\bar{q}_r$  is the mean frequency distribution (fig. 17).

The sum of the single fractions is described by the following equation:

$$Q_r(x=x_n) = \sum_{i=0}^n p_{r,i} \quad (\text{equation 5})$$

## 5. RETSCH Instruments

### 5.1. Test Sieves

For reliable and reproducible results in the context of quality assurance, the use of test sieves which correspond to the standards ISO 3310 or ASTM E11 is essential. The technical requirements and monitoring for test sieves are laid down in these standards. If a laboratory carries out quality control in accordance with ISO 9000 ff, the sieve shakers, test sieves and all other involved instruments (e.g. scales) have to be subjected to test agent monitoring.

The standard ISO 3310 stipulates which tolerances are allowed for the wire diameter ( $d$ ) of the woven sieve fabric and for the nominal mesh width ( $w$ ) of the apertures (fig. 20). For each mesh width  $w$  the value  $y$  is defined which indicates how much the mean real mesh width may differ from the nominal mesh width.

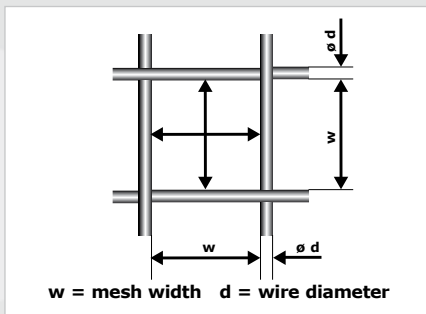
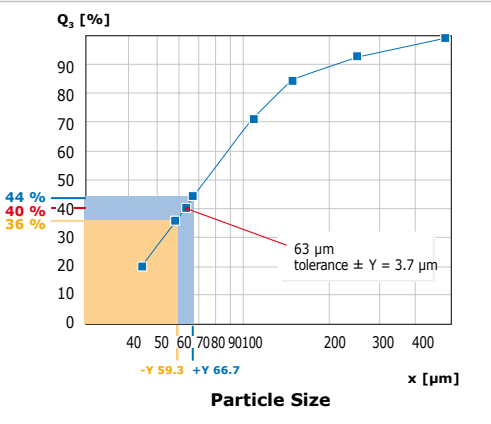

Fig. 20:  
Schematic of a sieve mesh





*Fig. 21:*  
Tolerance  $y$  of the nominal mesh width  
of 63  $\mu\text{m}$  acc. to ISO 3310-1 and its  
consequences

This can be demonstrated with a 63  $\mu\text{m}$  sieve (fig. 21). The tolerance  $y$  for a sieve with the nominal mesh width 63  $\mu\text{m}$  is  $\pm 3.7 \mu\text{m}$ . This means that the mean value of the mesh sizes must lie between 59.3  $\mu\text{m}$  and 66.7  $\mu\text{m}$ .

A look at the graph in figure 21 helps to understand why the knowledge of the real mesh width is so important for sieve analysis: if the mesh size is 63  $\mu\text{m}$ , 40% of the sample are smaller than 63  $\mu\text{m}$ . If, however, the mean real mesh width is 66.7  $\mu\text{m}$ , 44% of the particles are smaller than 66.7  $\mu\text{m}$ . If a user does not know the real mesh width, he would assume that 44% of the sample is smaller than 63  $\mu\text{m}$ .

**To prove the quality of the RETSCH test sieves, the following reports and certificates – validated by automated optical testing procedures – are available:**

- (a) Compliance certificate:  
certifies that the sieve has been tested in accordance with ISO 3310 and that the results lie within the allowed tolerance.

Optional certificates:

- (b) Inspection certificate (for test sieves according to ISO 3310-1 / ASTM E11):  
test report plus values of the measured mesh widths for warp and weft
- (c) Calibration certificate (for test sieves according to ISO 3310-1):  
(a) and (b) plus the standard deviation of the wire diameter and the mesh width; certifies that the sieve is at least 99.97 % in accordance with the standard.



**In addition to the requirements laid down by the standard, RETSCH test sieves offer significant benefits:**

The unique manufacturing process of RETSCH test sieves with a one-piece stainless steel sieve frame guarantees unrivaled stability and consistency for your sieving application. Paying close attention to mesh size and other specific requirements, the sieve fabric is precisely joined into the frame. Using a unique technology, which is only found in RETSCH test sieves, the fabric is then permanently and reliably tautened. The complete sieve is made from high alloy corrosion-resistant steel and is suitable for all areas of laboratory analytics, including pharmaceuticals and food. Each individual sieve passes a close optical inspection process ensuring conformity to standards. The sieve data (nominal mesh width, serial number, manufacturer, standard, dimensions) are laser engraved on the sieve frame and cannot be manipulated nor removed.

**Retsch**  
ANALYSENSIEB - TEST SIEVE - TAMIS D'ANALYS

Workauftrag/Commission: 2 x 100 0204  
 Certificate of compliance with the order according to 3.1 EN ISO 9001  
 Attestation de conformité à la commande: 2 x 100 0204

Serial No. / Serial No. / Numéro de série: 13005243  
 Mesh / Tamis / Taille: 40 µm  
 Mark / Standard / Norme: ASTM E11-08

Disque / Endprodukt / Produit: ...  
 This unit has been admitted to the ISO 9001 certification of our works and is subject to continuous control in accordance with the ISO 9001 certificate.

Caution: This unit is not suitable for use as a test sieve for the purpose of certification in accordance with the ISO 9001 certificate.

TEST SIEVE RECORD CARD											
Serial No.	Material	Mesh	Standard	Dimension	Material	Serial No.	Material	Mesh	Standard	Dimension	Material
13005243	Stainless steel	40 µm	ASTM E11-08	150 mm	Stainless steel	13005243	Stainless steel	40 µm	ASTM E11-08	150 mm	Stainless steel

(a) Compliance certificate

**Retsch**  
Inspection Certificate

Serial No. / Serial No. / Numéro de série: 13005243  
 Mesh / Tamis / Taille: 40 µm

Inspection Date / Date de l'inspection: 2015-01-15

Inspected by / Inspecté par: ...

Inspection Results / Résultats de l'inspection:

Standard	Mesh	Dimension	Material
ASTM E11-08	40 µm	150 mm	Stainless steel
ISO 2310-F	40 µm	150 mm	Stainless steel

Inspection Results / Résultats de l'inspection: ...

(b) Inspection certificate

**Retsch**  
Calibration Certificate

Serial No. / Serial No. / Numéro de série: 13005243  
 Mesh / Tamis / Taille: 40 µm

Calibration Date / Date de la calibration: 2015-01-15

Calibrated by / Calibré par: ...

Calibration Results / Résultats de la calibration:

Standard	Mesh	Dimension	Material
ISO 2310-F	40 µm	150 mm	Stainless steel

Calibration Results / Résultats de la calibration: ...

(c) Calibration certificate

## 5.2. Analytical Sieve Shakers

RETSCH offers a range of different sieving machines for reproducible sieve analyses:

	AS 200 basic	AS 200 digit	AS 200 control	AS 300 control
Sieving motion:	throwing motion with angular momentum	throwing motion with angular momentum	throwing motion with angular momentum	throwing motion with angular momentum
Measuring range:	20 µm - 25 mm	20 µm - 25 mm	20 µm - 25 mm	20 µm - 40 mm
Dry sieving / Wet sieving	yes / yes	yes / yes	yes / yes	yes / yes
Max. batch / Feed capacity:	3 kg	3 kg	3 kg	6 kg
Suitable sieve diameters [mm]:	100 / 150 / 200 / 203	100 / 150 / 200 / 203	100 / 150 / 200 / 203	100 / 150 / 200 / 203 / 305 / 315
Max. number of fractions (depends on sieve size):	9 / 17	9 / 17	9 / 17	9 / 17
Max. mass of sieve stack:	4 kg	4 kg	6 kg	10 kg
Amplitude:	analog, 0 - 3 mm	analog, 0 - 3 mm	digital, 0.2 - 3 mm	digital, 0.2 - 2 mm
Speed:	-	-	-	-
Sieve acceleration:	-	-	1.0 - 15.1 g	1.0 - > 10.0 g
Speed / no. of taps	-	-	-	-
Time display:	analog, 1 - 60 min	digital, 1 - 99 min	digital, 1 - 99 min	digital, 1 - 99 min
Interval operation:	-	yes	yes	yes
Vacuum:	-	-	-	-
Parameter combinations that can be stored:	-	-	9	9
Including test certificate / can be calibrated:	-	-	yes	yes
Serial interface:	-	-	yes	yes
Max. height of sieve stack:	450 mm	450 mm	450 mm	450 mm
Size (W x H x D):	400 x 230 x 350 mm	400 x 230 x 350 mm	400 x 230 x 350 mm	400 x 235 x 400 mm
Net weight:	~ 30 kg	~ 30 kg	~ 30 kg	~ 35 kg

AS 450 basic	AS 450 control	AS 200 jet	AS 200 tap	AS 400 control
throwing motion with angular momentum	throwing motion with angular momentum	dispersion by air jet	horizontal circular motion with taps	horizontal circular motion
25 µm - 125 mm	25 µm - 125 mm	10 µm - ~ 4 mm	20 µm - 25 mm	45 µm - 63 mm
yes / no	yes / yes	yes / no	yes / no	yes / no
15 kg	25 kg	0.3 - 100 g	3 kg	5 kg
400 / 450	400 / 450	203	200 / 203	100 / 150 / 200 / 203 / 305 / 315 / 400
10 / 7	13 / 9	1 / 2 with cyclone	7 / 13	7 / 9 / 17
50 kg	50 kg	-	6 kg	15 kg
digital, 0 - 2 mm	digital, 0.2 - 2.2 mm	-	-	-
-	-	digital, 5-55 min <sup>-1</sup> (nozzle)	-	digital, 50 - 300 min <sup>-1</sup>
-	0.6 - > 7.1 g	-	-	0.04 - 1.51 g
-	-	-	280 min <sup>-1</sup> / 150 min <sup>-1</sup>	-
digital 1 - 99 min	digital 1 - 99 min	digital 00:00 - 99:59	digital 1 - 99 min	digital 1 - 99 min
yes	yes	-	-	yes
-	-	0 - 9999 Pa / 0 - 100 mbar	-	-
1	9	9	-	9
-	no / yes	-	-	yes
-	yes	yes	-	yes
963 mm	963 mm	25/50 mm, 1"/2"	350 mm	450 mm
680 x 280 x 680 mm	714 x 435 x 658 mm	460 x 288 x 305 mm	750 x 650 x 450 mm; with sound enclosure cabinet: 735 x 675 x 530 mm	540 x 260 x 507 mm
~ 140 kg	~ 200 kg	~ 14 kg	~ 68 kg; with sound enclosure cabinet: ~ 92 kg	~ 70 kg



Vibratory Sieve Shaker  
AS 200 control

**AS 200 basic / AS 200 digit / AS 200 control /  
AS 300 control / AS 450 basic / AS 450 control**

The **3-D sieving motion** of the **vibratory sieve shakers** is generated by a spring-mass system which is activated by an electromagnetic drive. All sieve shakers mentioned above (except for the AS 450 basic) can be used for dry and wet sieving.

When selecting an instrument, the suitable sieve diameters and the feed capacity (load) have to be taken into account.

**The AS 200 versions differ with regards to operating convenience and cannot all be calibrated:**

	AS 200 basic	AS 200 digit	AS 200 control
Amplitude	analog	analog	digital
Time display	analog	digital	digital
Including test certificate / can be calibrated	no	no	yes



Vibratory Sieve Shaker  
AS 300 control

**AS 200 control / AS 300 control /  
AS 450 control**

All parameters such as vibration height, sieving time and interval operation can be selected and save digitally. All instruments feature a serial interface and can be controlled with RETSCH's evaluation software EasySieve®.

These sieve shakers are activated in their **natural frequency**, i.e. the sieving frequency is independent of the power frequency. The microprocessor-controlled measuring and control unit ensures a constant vibration height and thus highly reproducible sieving results (fig. 23 + 24).

To ensure reproducibility of the results even in short-time sieving processes, the default setting of the amplitude A can be switched to sieve acceleration g. This is called sieving with **equal acceleration**.

The following equation describes the sieve ratio K which is the ratio of the sieve acceleration  $g'$  to the opposite moving acceleration of gravity  $g$ :

$$K = A \cdot \frac{(2\pi f)^2}{g} = \frac{g'}{g}$$

(equation 6)

(K = sieve ratio,  
A = amplitude,  
f = natural frequency,  
g = acceleration of gravity,  
g' = sieve acceleration)

The K value is ideal when the state of statistical resonance is achieved (see chapter 3.3.), i.e. when the throw time of a particle corresponds to a period in the sieve bottom vibration.

This means in practice: as RETSCH sieve shakers are activated in their natural frequency, they are independent of the power frequency. The natural frequency of a sieve shaker is influenced by factors such as load (weight of the sieve stack). With increasing load, the natural frequency decreases. When the amplitude has been set, the K value changes (see equation 6). To keep the K value constant and ensure the optimum throwing motion, the sieve acceleration  $g'$  can be preset. If the sieve load increases, it compensates the lower natural frequency with a higher amplitude. The result is a consistent sieve acceleration, i.e. the energy input remains constant.



*Vibratory Sieve Shaker AS 450 control*

*Fig. 23: Varying sieve results due to manual setting of the oscillation amplitude*

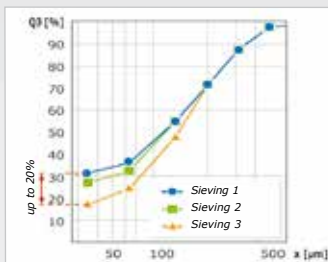

*Fig. 24: Reproducible sieve results due to manual setting of the oscillation amplitude*

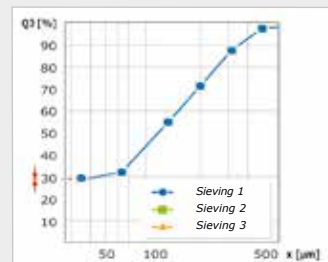



*Air Jet Sieving Machine  
AS 200 jet*

## AS 200 jet

**Air jet sieving** is a method where the sieve itself is not moved during the process. The material on the sieve is moved by a rotating jet of air: A vacuum cleaner which is connected to the sieving machine generates a vacuum inside the sieving chamber and sucks in fresh air through a rotating slit nozzle. When passing the narrow slit of the nozzle the air stream is accelerated and blown against the sieve mesh, dispersing the particles. Above the mesh, the air jet is distributed over the complete sieve surface and is sucked in with low speed through the sieve mesh. Thus the finer particles are transported through the mesh openings into the vacuum cleaner or, optionally, into a cyclone.



*Tap Sieve Shaker  
AS 200 tap*

## AS 200 tap

The **tap sieve shaker** combines horizontal circular motions via an eccentric with vertical taps generated by a tapping arm. As the number of rotations and taps is fixed, only the sieving time can be digitally adjusted.



*Horizontal Sieve Shaker  
AS 400 control*

## AS 400 control

The base plate of the AS 400 control performs **horizontal circular motions** via an eccentric. Speed, sieving and interval time (alternating rotation direction) can be set, displayed and monitored digitally. The AS 400 control is suitable for sieve diameters of up to 400 mm which makes it ideal for coarse bulk materials such as construction materials.

### 5.3. Evaluation Software

The evaluation of sieve analyses with the help of software programs is much quicker and more reliable than manual calculation, as miscalculations and graphic errors are avoided. In addition, manual evaluation is much more time-consuming.

With RETSCH's software EasySieve® evaluations can be performed quickly and reliably. All RETSCH sieve shakers of the series "control" and also the scale can be controlled with the software. The user is led step by step through the process (fig. 25).

All available parameters as well as those which have to be calculated can be entered in a clearly structured user interface. Routine parameters can be edited, saved and recalled at any time.

If a scale is connected, the corresponding data (dead weight of the sieves / weight of the loaded sieves) can be transferred directly to EasySieve®. If no scale is connected, the data can be entered manually.

The software calculates all standard particle size distributions as well as the characteristics of particle size. The results are presented as tables or charts in a measurement report which conforms to standards (fig. 26). The data can be exported to other software programs (e.g. MS Excel).



Fig. 25: EasySieve® for the quick and reliable evaluation of particle size analyses

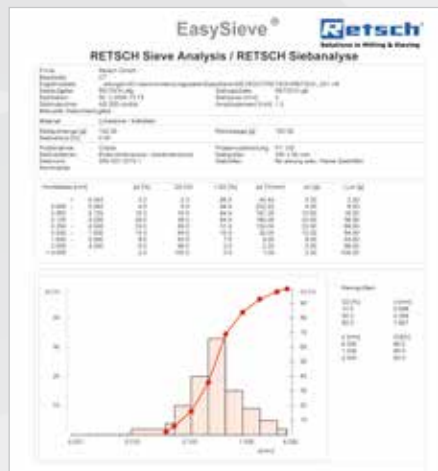

Fig. 26: EasySieve® Measurement Report



*Sample Dividers  
PT 100, PT 200  
and Sample Splitters*

## 5.4. Sample Divider

RETSCH offers different types of rifflers for exact sample division: the **rotary dividers PT 100 and PT 200** as well as **sample splitters** in various sizes (RT 6.5 – RT 75).

The rotary sample divider PT 100 splits the initial sample quantity into 6, 8 or 10 representative sub-samples, depending on the dividing head used. The dividing head rotates with a constant speed of 110 revolutions per minute, independent of load or power frequency. The laboratory bottles (30 ml – 500 ml) can be attached and released quickly and easily thanks to the quick-release clamps.

The rotary tube divider PT 200 is used for the extraction of up to 3 representative sub-samples from a large sample quantity. The remaining sample material is collected in a 30 liter vessel.

To guarantee a uniform material feed, the use of the **Vibratory Feeder DR 100** is recommended.

The RETSCH sample splitters are suitable for the precise manual division of fibrous samples which do not flow freely, such as secondary fuels or chipped wood. The sample splitters are available in 6 different sizes.



*Ultrasonic Baths  
UR 1 and UR 3*

## 5.5. Ultrasonic Baths

RETSCH ultrasonic baths in 3 sizes clean 1 to 5 test sieves thoroughly and gently. A high-frequency generator produces about 35,000 oscillations per second which are transferred into the cleaning solution. The instruments do not require maintenance and are easy to operate.



## 5.6. Fluid Bed Dryer

The Fluid Bed Dryer TG 200 is used for the gentle drying of up to 5 test sieves with 200 mm diameter. Air flow and temperature (40 °C to 150 °C) are continuously adjustable. The 1000 watt blower provides an air volume of 185 m<sup>3</sup>/h at idle speed; heater output is 2,000 watts.



*Fluid Bed  
Dryer  
TG 200*

## 6. Dynamic Image Analysis

### High resolution particle size and shape analysis



*CAMSIZER P4 and  
CAMSIZER XT*

The advantages which make sieve analysis the most popular method for particle size analysis are the traditionally wide usage and the cost-efficient equipment. But at the same time carrying out a sieve analysis is time consuming and only provides a relatively poor range of information on the measured particles. Therefore an alternative method for particle size analysis is becoming increasingly popular: Digital Image Analysis (DIA).

With the CAMSIZER range RETSCH TECHNOLOGY offers optical particle analyzers for the measurement of powders, granulates and suspensions.

The principle of DIA is simple: a particle stream is moved past a light source where the resulting shadow projections are detected and measured

in real time by a camera system. Depending on the particle size a CAMSIZER system typically analyses 10 000 to some million particles within few minutes.

Two different CAMSIZER systems are available:

The CAMSIZER XT specializes in very fine sample materials in a size range of 1  $\mu\text{m}$  to 3 mm.

The CAMSIZER P4 analyzes dry, free-flowing samples in a size range of 20  $\mu\text{m}$  to 30 mm.

Both systems work with the Dual Camera Technology, in which a Zoom camera measures the fine and a Basic camera measures the coarse particles.

	CAMSIZER P4	CAMSIZER XT
Sample material	dry, free-flowing bulk materials: granulates, extrudates, pellets, sugar, salt, sand, etc.	bulk goods, powders & suspensions
Measuring range	20 $\mu\text{m}$ - 30 mm	1 $\mu\text{m}$ - 3 mm (dry, compressed air) 1 $\mu\text{m}$ - 1 mm (wet) 10 $\mu\text{m}$ - 7 mm (dry, free fall)
Dispersion	free fall	compressed air, wet dispersion, free fall
Comparable to sieving	yes	yes

The Dual Camera Technology of the CAMSIZER systems surpasses other image analysis systems with regard to dynamic measuring range, shape sensitivity and resolution. The division of the measurement range between two cameras enables creating optimum measurement conditions for both fine and coarse particles without having to compromise with worse resolution, accuracy or detection limits.

The measurement range of the systems comprises more than three decades without having to alter the system settings (no change of lens, no adjustment works and no adjustment of measurement range).

The measurement speed does not only depend on the frame rate of the cameras but also on the size of the detection field and thus on the amount of particles in an image. Only by this reproducible measurement results within short analysis times are possible. If similar should be obtained with only one camera, this needed to have more than 40 Megapixels and a refresh rate of 30 Hz which is technically not possible at present.

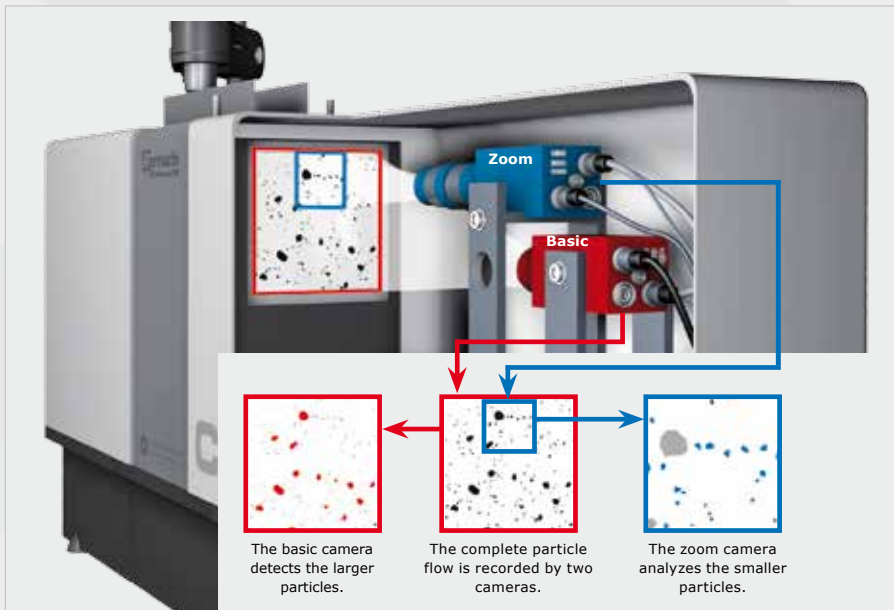

*Measurement principle of CAMSIZER P4 with zoom and basic camera*

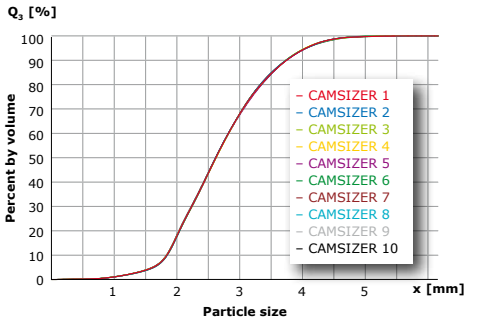

*Excellent reproducibility: 10 measurements of the same sample with 10 different CAMSIZER systems. The curves perfectly match each other.*

Sieve analysis is the most commonly used basis for quality standards and product specifications which are the basis for the communication between suppliers and purchasers. A fast and powerful alternative to sieve analysis has to take this into account and must be able to deliver fully compatible measurement results. Therefore the CAMSIZER software is equipped with algorithms which allow matching sieve analyses. In this way a vast number of users could replace sieving by the CAMSIZER system without having to abstain from the familiar quality characteristics.

Due to the automatic measurement and wear-free operation the measurement results are more reliable and more reproducible.

Moreover CAMSIZER users benefit from additional information like particle length and width (fibres and extrudates) or particle shape (e.g. angularity of abrasives) which sieve analysis cannot deliver.

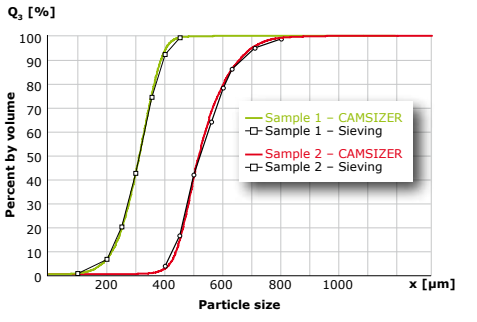

*Comparison of CAMSIZER results with sieve analysis for two different samples*

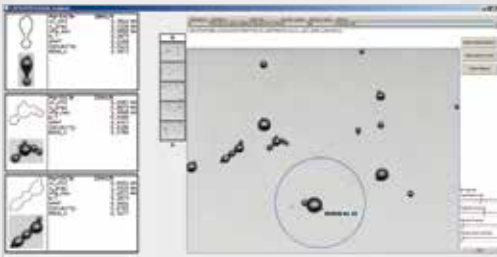

*All particle images and corresponding measurement parameters can be optionally stored in the particle library.*

## 7. Summary

Sieve analysis is frequently used in areas such as research & development, quality control of raw materials, intermediate and finished products as well as in production monitoring.

Meaningful and reliable sieve analysis results can only be achieved if the premises described in this guide are taken account of. Modern calibrated sieve shakers such as the AS series combined with calibrated RETSCH test sieves and a comprehensive evaluation software allow for accurate sieving results with world wide reproducibility.

## 8. Annex

### 8.1. Sieve Standards with Comparison Table

There are various international sieve standards which means that comparable mesh sizes may be named differently. The most common sieves are those which comply with the standards ISO 3310 and ASTM E11.

The table on the next pages gives an overview of the different standards:

8.1. Sieve Standards with Comparison Table



International Comparison Table for Test Sieves							Table 1 – 125-1 mm			
ISO 565 ISO 3310 Table 1, Sizes in Millimetre			DE	FR	GB	NL	USA		CAN	Tyler®
Principal sizes	Supplementary sizes		DIN ISO 3310	NF ISO 3310	BS 410 / BS ISO 3310	NEN 2560	ASTM E 11 # ASTM E 323 ■●		CAN/CGSB-8.2 M88 metric	TYLER Screen Scale
R20/3	R 20	R 40/3								
w	w	w	w	w	w	w	w	Inch / No.	w	Mesh
125	125	125	125	125	125	125	125	5 in.	125	
	112		112	112	112	112			112	
		106	106	106	106	106	106	4 1/4 in.		
	100		100	100	100	100	100*	4 in.*	100	
90	90	90	90	90	90	90	90	3 1/2 in.	90	
	80		80	80	80	80			80	
		75	75	75	75	75	75	3 in.		
	71		71	71	71	71			71	
63	63	63	63	63	63	63	63	2 1/2 in.	63	
	56		56	56	56	56			56	
		53	53	53	53	53	53	2 1/8 in.		
	50		50	50	50	50	50*	2 in.*	50	
45	45	45	45	45	45	45	45	1 3/4 in.	45	
	40		40	40	40	40			40	
		37,5	37,5	37,5	37,5	37,5	37,5	1 1/2 in.		
	35,5		35,5	35,5	35,5	35,5			35,5	
31,5	31,5	31,5	31,5	31,5	31,5	31,5	31,5	1 1/4 in.	31,5	
	28		28	28	28	28			28	
		26,5	26,5	26,5	26,5	26,5	26,5	1 1/16 in.		1,05 in.
	25		25	25	25	25	25,0*	1 in.*	25	
22,4	22,4	22,4	22,4	22,4	22,4	22,4	22,4	7/8 in.	22,4	0,883 in.
	20		20	20	20	20			20	
		19	19	19	19	19	19	3/4 in.		0,742 in.
	18		18	18	18	18			18	
16	16	16	16	16	16	16	16	5/8 in.	16	0,624 in.
	14		14	14	14	14			14	
		13,2	13,2	13,2	13,2	13,2	13,2	17/32 in.		0,525 in.
	12,5		12,5	12,5	12,5	12,5	12,5*	1/2 in.*	12,5	
11,2	11,2	11,2	11,2	11,2	11,2	11,2	11,2	7/16 in.	11,2	0,441 in.
	10		10	10	10	10			10	
		9,5	9,5	9,5	9,5	9,5	9,5	3/8 in.		0,371 in.
	9		9	9	9	9			9	
8	8	8	8	8	8	8	8	5/16 in.	8	2 1/2
	7,1		7,1	7,1	7,1	7,1			7,1	
		6,7	6,7	6,7	6,7	6,7	6,7	17/64 in.		3
	6,3		6,3	6,3	6,3	6,3	6,3*	1/4 in.*	6,3	
5,6	5,6	5,6	5,6	5,6	5,6	5,6	5,6	7/32	5,6	3 1/2
	5		5	5	5	5			5	
		4,75	4,75	4,75	4,75	4,75	4,75	3/16		4
	4,5		4,5	4,5	4,5	4,5			4,5	
4	4	4	4	4	4	4	4	5/32	4	5
	3,55		3,55	3,55	3,55	3,55			3,55	
		3,35	3,35	3,35	3,35	3,35	3,35	1/8		6
	3,15		3,15	3,15	3,15	3,15			3,15	
2,8	2,8	2,8	2,8	2,8	2,8	2,8	2,8	7/64	2,8	7
	2,5		2,5	2,5	2,5	2,5			2,5	
		2,36	2,36	2,36	2,36	2,36	2,36	3/62		8
	2,24		2,24	2,24	2,24	2,24			2,24	
2	2	2	2	2	2	2	2	0,078	2	9
	1,8		1,8	1,8	1,8	1,8			1,8	
		1,7	1,7	1,7	1,7	1,7	1,7	0,066		10
	1,6		1,6	1,6	1,6	1,6			1,6	
1,4	1,4	1,4	1,4	1,4	1,4	1,4	1,4	0,055	1,4	12
	1,25		1,25	1,25	1,25	1,25			1,25	
		1,18	1,18	1,18	1,18	1,18	1,18	0,045		14
	1,12		1,12	1,12	1,12	1,12			1,12	
1	1	1	1	1	1	1	1	0,039	1	16
ISO 3310-1	wire-cloth #		125-1	125-1	125-1	125-1	125-1		125-1	26,5-1
ISO 3310-2	round holes ●		125-1	125-1	125-1	125-1	125-1			
	square holes ■		125-4	125-4	125-4	125-4	125-3.35			

\* ASTM Supplementary values

International Comparison Table for Test Sieves							Table 2 – 900-5 µm			
ISO 565 ISO 3310 Table 2, Sizes in Micrometer			DE	FR	GB	NL	USA		CAN	Tyler®
Principal sizes	Supplementary sizes		DIN ISO 3310	NF ISO 3310	BS 410 / BS ISO 3310	NEN 2560	ASTM E 11 # ASTM E 323 ■●		CAN/ CGSB-8.2- M88 metric	TYLER Screen Scale
	R20/3	R 20	R 40/3							
w	w	w	w	w	w	w	w	Inch / No.	w	Mesh
	900		900	900	900	900			900	
		850	850	850	850	850	850	20		20
	800		800	800	800	800			800	
710	710	710	710	710	710	710	710	25	710	24
	630		630	630	630	630			630	
		600	600	600	600	600	600	30		28
	560		560	560	560	560			560	
500	500	500	500	500	500	500	500	35	500	32
	450		450	450	450	450			450	
		425	425	425	425	425	425	40		35
	400		400	400	400	400			400	
355	355	355	355	355	355	355	355	45	355	42
	315		315	315	315	315			315	
		300	300	300	300	300	300	50		48
	280		280	280	280	280			280	
250	250	250	250	250	250	250	250	60	250	60
	224		224	224	224	224			224	
		212	212	212	212	212	212	70		65
	200		200	200	200	200			200	
180	180	180	180	180	180	180	180	80	180	80
	160		160	160	160	160			160	
		150	150	150	150	150	150	100		100
	140		140	140	140	140			140	
125	125	125	125	125	125	125	125	120	125	115
	112		112	112	112	112			112	
		106	106	106	106	106	106	140		150
	100		100	100	100	100			100	
90	90	90	90	90	90	90	90	170	90	170
	80		80	80	80	80			80	
		75	75	75	75	75	75	200		200
	71		71	71	71	71			71	
63	63	63	63	63	63	63	63	230	63	250
	56		56	56	56	56			56	
		53	53	53	53	53	53	270		270
	50		50	50	50	50			50	
45	45	45	45	45	45	45	45	325	45	325
	40		40	40	40	40			40	
		38	38	38	38	38	38	400		400
R 10	36		36	36	36	36			36	
32			32	32	32	32	32	450		450
25			25	25	25	25	25	500		500
20			20	20	20	20	20	635		635
16 (e)			16 (e)	16 (e)		16 (e)	15 (e)			
10 (e)			10 (e)	10 (e)		10 (e)	10 (e)			
5 (e)			5 (e)	5 (e)		5 (e)	5 (e)			
ISO 3310-1	wire-cloth #		900-20	900-20	900-20	900-20	850-20	850-20	900-32	850-20
ISO 3310-3	Electroformed (e)		500-5	500-5		500-5	500-5			

## ISO 3310-1 Compliance Certificate



### ANALYSENSIEB - TEST SIEVE - TAMIS D' ANALYS

<b>Werksbescheinigung nach 2.1 EN 10204</b>	<b>Certificate of compliance with the order according to 2.1 EN 10204</b>	<b>Attestation de conformité à la commande 2.1 EN 10204</b>
---	---	---

Serien Nr./ Serial No./ Numéro de serie	Maschenweite / Mesh width / Overture de maille	Norm / Standard / Norme
--	---	-------------------------

13008946

45  $\mu\text{m}$

ISO 3310-1

Dieses Analysensieb wurde  
sorgfältig in unserem Werk  
geprüft und entspricht der oben  
genannten Norm.

This test sieve has been submitted to  
careful examination in our works and  
is certified to conform with a.m.  
standard.

Ce tamis d'analyse a été  
contrôlé soigneusement à  
l'usine et correspond à la  
norme nommé ci-dessus.

#### TEST SIEVE RECORD CARD

Datum der Messung	Nutzungs- dauer Sieb	Sichtprü- fung	Mittelwert der Maschenweite in Kettrichtung +/-Y	Mittelwert der Maschenweite in Schussrichtung +/- Y	Standardsab- weichung in Kettrichtung $\sigma_0$	Standardsab- weichung in Schussrich- tung $\sigma_0$	Dokumentenart unbekannt = 0 Werksbescheinigung = 1 Abnahmeprüfzeugnis = 2 Kalibrierungszertifikat = 3
Date of inspection	Time used	Visual survey	Average aperture size warp +/-Y	Average aperture size weft +/-Y	Standard deviation warp $\sigma_0$	Standard deviation weft $\sigma_0$	Type of certificate Unknown = 0 Compliance = 1 Inspection = 2 Calibration = 3
11.03.2013	neu / new	* C <input checked="" type="checkbox"/> * NC <input type="checkbox"/>	* C <input checked="" type="checkbox"/> * NC <input type="checkbox"/>	* C <input checked="" type="checkbox"/> * NC <input type="checkbox"/>	* C <input checked="" type="checkbox"/> * NC <input type="checkbox"/>	* C <input checked="" type="checkbox"/> * NC <input type="checkbox"/>	1



## ISO 3310-1 Inspection Certificate



Messdokument \* Measuring Document

Abnahmeprüfzeugnis nach EN 10204 3.1  
Inspection Certificate according to EN 10204 3.1

Vermessung <=10mm mit vollautomatischem Bildverarbeitungssystem. Vermessung >10mm mit Messschieber  
Measurement <=10mm with fully automatic video imaging system. Measurement >10mm with Vernier

Das für die Überprüfung der Siebgewebe eingesetzte Messmittel unterliegt der Messmittelüberwachung gemäß DIN ISO 9000 ff. Die Kalibrierung der Messmittel für Gewebe <=10mm erfolgt mit von der "Physikalisch-Technische-Bundesanstalt" (PTB) Braunschweig, unter dem Kalibrierzeichen 4101-PTB-04 kalibrierten Objekten. Damit ist eine Rückführung auf nationale Normale sichergestellt, mit denen die PTB die physikalischen Einheiten in Übereinstimmung mit dem internationalen Einheitensystem (SI) darstellt. Die Kalibrierung der Messmittel für Gewebe >10mm ist rückführbar auf 0116 DKD-K-25501 und 0131 DKD-K-25501	The measuring equipment used to examine the mesh is subject to periodical inspection according to DIN ISO 9000 ff. The calibration of measuring equipment for mesh <=10mm is carried out using objects which are calibrated by the "Physikalisch-Technische-Bundesanstalt" (PTB) Braunschweig, Germany, with the calibration No. 4101-PTB-04. Herewith is the traceability to national standards insured, with which the PTB presents the physical dimensions in accordance with the International Units System (SI). The calibration of measuring equipment for mesh >10mm is traceable to 0116 DKD-K-25501 and 0131 DKD-K-25501
<b>Sieb Identifikation / Sieve identification</b>	
Sieb Nr./Sieve No. : 13008946 Durchmesser/diameter : 200 mm Draht/wire (d) : 32,0 µm Nennöffnungsweite/nominal aperture size (W): <b>45,0 µm</b>	
<b>Toleranzen/Tolerances</b>	
w-y : 41,9    w+x : 66,9    σ : 8,3    d <sub>max</sub> : 37,0 µm    d <sub>nom</sub> : 32,0 µm w+y : 48,1    d <sub>min</sub> : 27,0 µm	
<b>Anzahl der gemessenen Öffnungen - Drahtdurchmesser/Number of measured apertures - wire diameter</b>	
410 / 430	
<b>Legende / Glossary</b>	<b>Ergebnis / Result</b>
* C <input type="checkbox"/> konform / conform * NC <input type="checkbox"/> nicht konform / non conform	Dieses Sieb ist / This sieve is * C <input checked="" type="checkbox"/> * NC <input type="checkbox"/> mit der Norm / according to the standard <b>ISO 3310-1</b>
<b>KETTE / Warp</b> * C <input checked="" type="checkbox"/> * NC <input type="checkbox"/> <b>Ergebnisse / Results</b> W <sub>max</sub> : 47,4 µm W: 44,8 µm Sigma-Test * NC <input type="checkbox"/>	<b>SCHUSS / Weft</b> * C <input checked="" type="checkbox"/> * NC <input type="checkbox"/> <b>Ergebnisse / Results</b> W <sub>max</sub> : 47,6 µm W: 45,2 µm Sigma-Test * NC <input type="checkbox"/>
<b>Kommentar / Comments</b>	
_____ _____	
Dieses Abnahmeprüfzeugnis wurde automatisch erstellt und ist daher ohne Unterschrift gültig. This inspection certificate has been automatically produced and is therefore valid without signature	Der Werksachverständige / The factory-authorised inspector Holger Mersch Druckdatum / Date of printing: 13.03.2013

## ISO 3310-1 Calibration Certificate



Messdokument \* Measuring Document

Abnahmeprüfzeugnis nach EN 10204 3.1 (Kalibrierungszertifikat)  
Inspection Certificate according to EN 10204 3.1 (Calibration Certificate)

Vermessung <=10mm mit vollautomatischem Bildverarbeitungssystem. Vermessung >10mm mit Messschieber  
Measurement <=10mm with fully automatic video imaging system. Measurement >10mm with Vernier

<p>Das für die Überprüfung der Siebwebze eingesetzte Messmittel unterliegt der Messmittelüberwachung gemäß DIN ISO 9000 ff. Die Kalibrierung der Messmittel für Gewebe &lt;=10mm erfolgt mit von der "Physikalisch-Technische-Bundesanstalt" (PTB) Braunschweig, unter dem Kalibrierzeichen 4101-PTB-04 kalibrierten Objekten. Damit ist eine Rückführung auf nationale Normale sichergestellt, mit denen die PTB die physikalischen Einheiten in Übereinstimmung mit dem internationalen Einheitenystem (SI) darstellt. Die Kalibrierung der Messmittel für Gewebe &gt;10mm ist rückführbar auf 0116 DKD-K-25501 und 0131 DKD-K-25501</p>	<p>The measuring equipment used to examine the mesh is subject to periodical inspection according to DIN ISO 9000 ff. The calibration of measuring equipment for mesh &lt;=10mm is carried out using objects which are calibrated by the "Physikalisch-Technische-Bundesanstalt" (PTB) Braunschweig, Germany, with the calibration No. 4101-PTB-04. Herewith is the traceability to national standards insured, with which the PTB presents the physical dimensions in accordance with the International Units System (SI). The calibration of measuring equipment for mesh &gt;10mm is traceable to 0116 DKD-K-25501 and 0131 DKD-K-25501</p>
<b>Sieb Identifikation / Sieve Identification</b>	
Sieb Nr./Sieve No. : 13008946 Durchmesser/diameter : 200 mm Draht/wire (d) : 32,0 µm Nennöffnungswerte/nominal aperture size (W): <b>45,0 µm</b>	
<b>Toleranzen/Tolerances</b>	
w-y : 41,9    w+x : 65,9    σ : 8,3    d <sub>max</sub> : 37,0 µm    d <sub>nom</sub> : 32,0 µm w-y : 48,1    d <sub>min</sub> : 27,0 µm	
<b>Anzahl der gemessenen Öffnungen - Drahtdurchmesser/Number of measured apertures - wire diameter</b>	
410 / 430	
<b>Legende / Glossary</b> * C <input type="checkbox"/> konform / conform * NC <input type="checkbox"/> nicht konform / non conform	<b>Ergebnis / Result</b> Dieses Sieb ist / This sieve is * C <input checked="" type="checkbox"/> * NC <input type="checkbox"/> mit der Norm / according to the standard <b>ISO 3310-1</b>
<b>KETTE / Warp</b> * C <input checked="" type="checkbox"/> * NC <input type="checkbox"/> <b>Ergebnisse / Results</b> W <sub>max</sub> : 47,4 µm W : <b>44,8 µm</b> σ <sub>S, Cal</sub> : 1,2	<b>SCHUSS / Weft</b> * C <input checked="" type="checkbox"/> * NC <input type="checkbox"/> <b>Ergebnisse / Results</b> W <sub>max</sub> : 47,6 µm W : <b>45,2 µm</b> σ <sub>S, Cal</sub> : 1
<b>Kontrolle der Drahtdurchmesser / Verification of the wire diameter</b>	
Ergebnisse / Results <b>KETTE / Warp</b> d̄ : 32,3 µm <b>SCHUSS / Weft</b> d̄ : 33,2 µm    * C <input checked="" type="checkbox"/> * NC <input type="checkbox"/>	
<b>Kommentar / Comments</b>	
Dieses Abnahmeprüfzeugnis wurde automatisch erstellt und ist daher ohne Unterschrift gültig. This inspection certificate has been automatically produced and is therefore valid without signature	Der Werkssachverständige / The factory-authorised inspector Holger Mersch Druckdatum/ Date of printing: 13.03.2013

Retsch GmbH Retsch-Allee 1-5, D-42781 Haan Germany. Tel. Int. +49 (0) 2104 - 2333-100. Fax. Int. +49 (0) 2104 - 2333-199.  
Email: info@retsch.com. Internet: http://www.retsch.com

## ASTM E11 Compliance Certificate



### ANALYSENSIEB - TEST SIEVE - TAMIS D' ANALYS

**Werksbescheinigung nach 2.1 EN 10204**    
 **Certificate of compliance with the order according to 2.1 EN 10204**    
 **Attestation de conformité à la commande 2.1 EN 10204**

Serien Nr./ Serial No./ Numéro de serie    
 Maschenweite / Mesh width / Overture de maille    
 Norm / Standard / Norme

13005243                                  45  $\mu\text{m}$                                   ASTM E11-09

Dieses Analysensieb wurde sorgfältig in unserem Werk geprüft und entspricht der oben genannten Norm.

This test sieve has been submitted to careful examination in our works and is certified to conform with a.m. standard.

Ce tamis d'analyse a été contrôlé soigneusement à l'usine et correspond à la norme nommé ci-dessus.

#### TEST SIEVE RECORD CARD

Datum der Messung	Nutzungsdauer Sieb	Sichtprüfung	Mittelwert der Maschenweite in Kettrichtung +/-Y	Mittelwert der Maschenweite in Schussrichtung +/-Y	Standardabweichung in Kettrichtung $\sigma_0$	Standardabweichung in Schussrichtung $\sigma_0$	Dokumentenart unbekannt = 0 Werksbescheinigung = 1 Abnahmeprüfzeugnis = 2 Kalibrierungszertifikat = 3
Date of inspection	Time used	Visual survey	Average aperture size warp +/-Y	Average aperture size weft +/-Y	Standard deviation warp $\sigma_0$	Standard deviation weft $\sigma_0$	Type of certificate Unknown = 0 Compliance = 1 Inspection = 2 Calibration = 3
12.02.2013	new / neu	* C <input checked="" type="checkbox"/> * NC <input type="checkbox"/>	* C <input checked="" type="checkbox"/> * NC <input type="checkbox"/>	* C <input checked="" type="checkbox"/> * NC <input type="checkbox"/>	* C <input checked="" type="checkbox"/> * NC <input type="checkbox"/>	* C <input checked="" type="checkbox"/> * NC <input type="checkbox"/>	1

### ASTM E11 Inspection Certificate



Messdokument \* Measuring Document

Abnahmeprüfzeugnis nach EN 10204 3.1  
Inspection Certificate according to EN 10204 3.1

Vermessung <=10mm mit vollautomatischem Bildverarbeitungssystem. Vermessung >10mm mit Messschieber  
Measurement <=10mm with fully automatic video imaging system. Measurement >10mm with Vernier

<p>Das für die Überprüfung der Siebgewebe eingesetzte Messmittel unterliegt der Messmittelüberwachung gemäß DIN ISO 9000 ff. Die Kalibrierung der Messmittel für Gewebe &lt;=10mm erfolgt mit von der "Physikalisch-Technische-Bundesanstalt" (PTB) Braunschweig unter dem Kalibrierzeichen 4101-PTB-04 kalibrierten Objekten. Damit ist eine Rückführung auf nationale Normale sichergestellt, mit denen die PTB die physikalischen Einheiten in Übereinstimmung mit dem Internationalen Einheitensystem (SI) darstellt. Die Kalibrierung der Messmittel für Gewebe &gt;10mm ist rückführbar auf 0116 DKD-K-25501 und 0131 DKD-K-25501</p>	<p>The measuring equipment used to examine the mesh is subject to periodical inspection according to DIN ISO 9000 ff. The calibration of measuring equipment for mesh &lt;=10mm is carried out using objects which are calibrated by the "Physikalisch-Technische-Bundesanstalt" (PTB) Braunschweig, Germany, with the calibration No. 4101-PTB-04. Herewith is the traceability to national standards insured, with which the PTB presents the physical dimensions in accordance with the International Units System (SI). The calibration of measuring equipment for mesh &gt;10mm is traceable to 0116 DKD-K-25501 and 0131 DKD-K-25501</p>
Sieb Identifikation / Sieve Identification	
Sieb Nr./Sieve No. : 13005243 Durchmesser/diameter : 200 mm Draht/wire (d) : 32,0 µm Nennöffnungsweite/nominal aperture size (W): <b>45,0 µm</b>	
Toleranzen/Tolerances	
w-y : 41,9    w+x : 66,9    σ : 7,1    d <sub>max</sub> : 37,0 µm    d <sub>nom</sub> : 32,0 µm w+y : 48,1    d <sub>min</sub> : 27,0 µm	
Anzahl der gemessenen Öffnungen - Drahtdurchmesser/Number of measured apertures - wire diameter	
399 / 439	
Legende / Glossary	Ergebnis / Result
* C <input type="checkbox"/> konform / conform * NC <input type="checkbox"/> nicht konform / non conform	Dieses Sieb ist / This sieve is * C <input checked="" type="checkbox"/> * NC <input type="checkbox"/> mit der Norm / according to the standard <b>ASTM E11-09</b>
KETTE / Warp    * C <input checked="" type="checkbox"/> * NC <input type="checkbox"/> Ergebnisse / Results	SCHUSS / Weft    * C <input checked="" type="checkbox"/> * NC <input type="checkbox"/> Ergebnisse / Results
Kommentar / Comments	
Dieses Abnahmeprüfzeugnis wurde automatisch erstellt und ist daher ohne Unterschrift gültig. This inspection certificate has been automatically produced and is therefore valid without signature	Der Werksachverständige / The factory-authorized inspector Holger Mersch Druckdatum/ Date of printing: 13.03.2013

## Traceability

The measuring equipment used to examine the mesh is subject to periodical inspection according to DIN ISO 9000 ff. The calibration of measuring equipment for mesh  $\leq 10$  mm is carried out using objects which are calibrated by the PTB Braunschweig ("Physikalisch-Technische-Bundesanstalt"), Germany, with the calibration No. 4101-PTB-04. Herewith is the traceability to national standards insured, with which the PTB presents the physical dimensions in accordance with the International Units System (SI). The calibration of measuring equipment for mesh  $> 10$ mm is traceable to 0116 DKD-K-25501 and 0131 DKD-K-25501.

### 8.3. Sieve Analysis Parameters

With EasySieve® the sieving results can be displayed as diagrams and parameters.

The following characteristics of particle size distributions can be determined with EasySieve®:

$p_3(x_1, x_2)$	<b>Fractions</b> $p_3(x_1, x_2)$ – volume proportion of particles in the range $(x_1, x_2)$ : $p_3(x_1, x_2) = Q_3(x_2) - Q_3(x_1)$ (indicates the percentage by volume of a fraction)
$Q_3(x)$	<b>Cumulative distribution</b> $Q_3(x)$ , based on volume: volume proportion of particles smaller than $x$ in proportion to the total volume
$1 - Q_3(x)$	<b>Cumulative distribution of residue</b> $1 - Q_3(x)$ , based on volume
$q_3(x)$	<b>Density distribution</b> $q_3(x)$ , based on volume: 1. Derivative of $Q_3(x)$ $q_3(x) = \frac{dQ_3(x)}{dx}$

For sieving, percent by volume corresponds to percent by weight (the mass is determined by weighing)

#### Parameters:

$Q_3(x)$	<b><math>Q_3</math> value</b> , whereat a given particle diameter $x$ is reached, based on volume
$x_1(Q_3)$	<b><math>x</math> value</b> , whereat a given $Q_3$ value is reached, based on volume
$SPAN_3$	<b>Span value</b> , based on volume: $SPAN_3 = \frac{x(Q_{3,3}) - x(Q_{3,1})}{x(Q_{3,2})}$  Calculated from three $x(Q_3)$ values. The first index indicates that the values are volume-related. The first index was omitted from the program. The SPAN value indicates the width of distribution.
$U_3$	<b>Non-uniformity</b> , based on volume: $U_3 = \frac{x_{60}}{x_{10}}$  $x_{10}$ : $x$ value for $Q_3 = 10\%$ $x_{60}$ : $x$ value for $Q_3 = 60\%$

**RRSB characteristics:**

n	<b>Slope of the RRSB line</b>
d'	<b>x value, whereat the line reaches a value of 0.632</b>
Correlation	<b>Correlation</b> between the RRSB line and Q(x) in the range between Q <sub>1</sub> and Q <sub>2</sub>

The RRSB parameters can only be calculated, if the Q<sub>3</sub> values of at least two sieve cuts lie between 5% and 95%.

**Indirect determination of specific surfaces S<sub>v</sub> and S<sub>m</sub>:**

S <sub>v</sub>	<b>Specific surface</b> $S_v = \frac{\text{surface of all particles}}{\text{volume of all particles}}$
S <sub>m</sub>	<b>Specific surface</b> for a given specific density $S_m = \frac{\text{surface of all particles}}{\text{mass of all particles}}$ If no material density was defined, this parameter cannot be selected.

X <sub>st</sub>	<b>Sauter diameter</b> If the complete volume of the particles of a bulk was transformed into spheres of identical size, whose complete surface equalled that of the particles, then these spheres would have the Sauter diameter. $x_{st} = \frac{6}{S_v}$
AFS no.	<b>AFS number</b> The ASF no. is used to classify foundry or core sand  Can only be calculated if the appropriate sieves are used.  The sieves have to be a subset of the ASF series 0.020 mm, 0.063 mm, 0.090 mm, 0.125 mm, 0.180 mm, 0.250 mm, 0.355 mm, 0.500 mm, 0.710 mm, 1 mm, 1.4 mm, 2 mm, 2.8 mm, 4 mm, 5.6 mm. Moreover, between the smallest and the biggest sieve all ASF sieves have to be included.



**Headquarters:**

**RETSCH GmbH**  
RETSCH-Allee 1-5  
42781 Haan · Germany

Phone +49 (0) 21 04 / 23 33-100  
Fax +49 (0) 21 04 / 23 33-199  
E-Mail [info@retsched.com](mailto:info@retsched.com)  
Web [www.retsched.com](http://www.retsched.com)

You will find a current list of all world wide distributors at [www.retsched.com](http://www.retsched.com).

part of **VERDER**  
scientific

